



The figures appearing below the notes represent slide positions.

E F F# Gb G G# Ab A A# Bb B



7 6 5 4 3 2 1 4

C C# Db D D# Eb E F F# Gb



6 5 4 3 2 1 5

G G# Ab A A# Bb B C C# Db D



4 3 2 1 4 3 2 1

D# Eb E F F# Gb G G# Ab A A# Bb

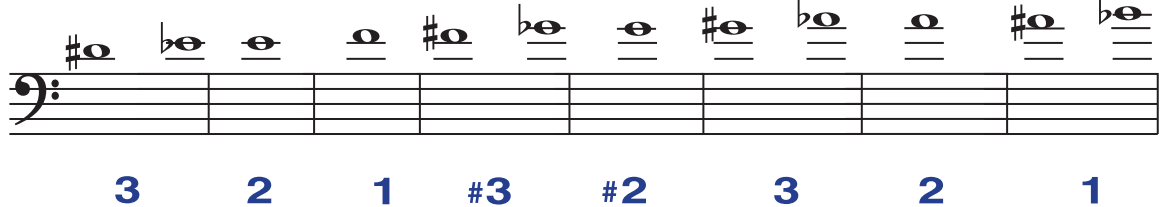

3 2 1 #3 #2 3 2 1

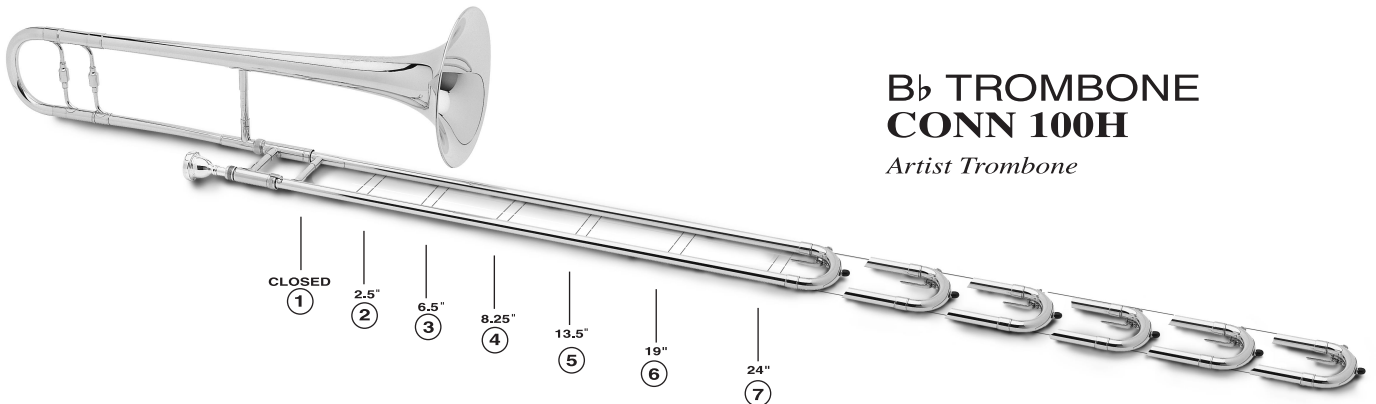

**B \flat TROMBONE
CONN 100H**

Artist Trombone

The figures appearing in the bottom row below the notes in the first and second lines represent the positions used for playing Bb Trombone with F valve attachment. "T" prefix indicates that F change valve or "trigger" is to be depressed, thereby changing the instrument to the key of F. Approximate F trombone slide locations below are in relation to the Bb Trombone positions - 2 1/4 is slightly below the normal 2nd position, 3 1/2 is halfway between the 3rd and 4th, etc.

C C# D♭ D D# E♭ E F F# G♭ G G# A♭

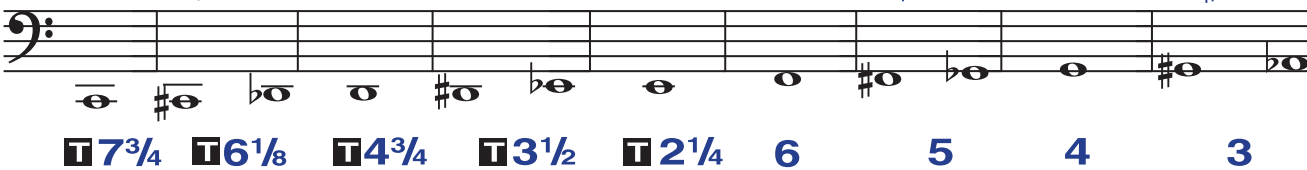

7^{3/4} 6^{1/8} 4^{3/4} 3^{1/2} 2^{1/4} 6 5 4 3

A A# B♭ B C C# D♭ D D# E♭ E F



4^{3/4} 3^{1/2} 2^{1/4} 1 5 4 3 2 1

F# G♭ G G# A♭ A A# B♭ B C C# D♭ D



5 4 3 2 1 4 3 2 1

D# E♭ E F F# G♭ G G# A♭ A A# B♭

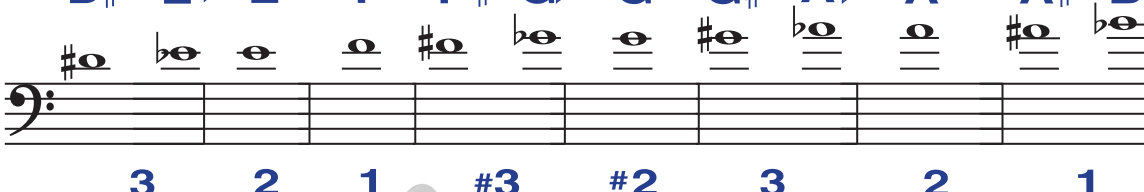

3 2 1 #3 #2 3 2 1

